



# holoride retrofit guide

# Table of content

What's in the box	01
Overview of holoride retrofit	02
Prerequisites to use holoride retrofit	03
Mounting location in car	04
Pair holoride retrofit with VR headset	08
Button and LED signals	10
Check battery status	10

# 1. What's in the box?

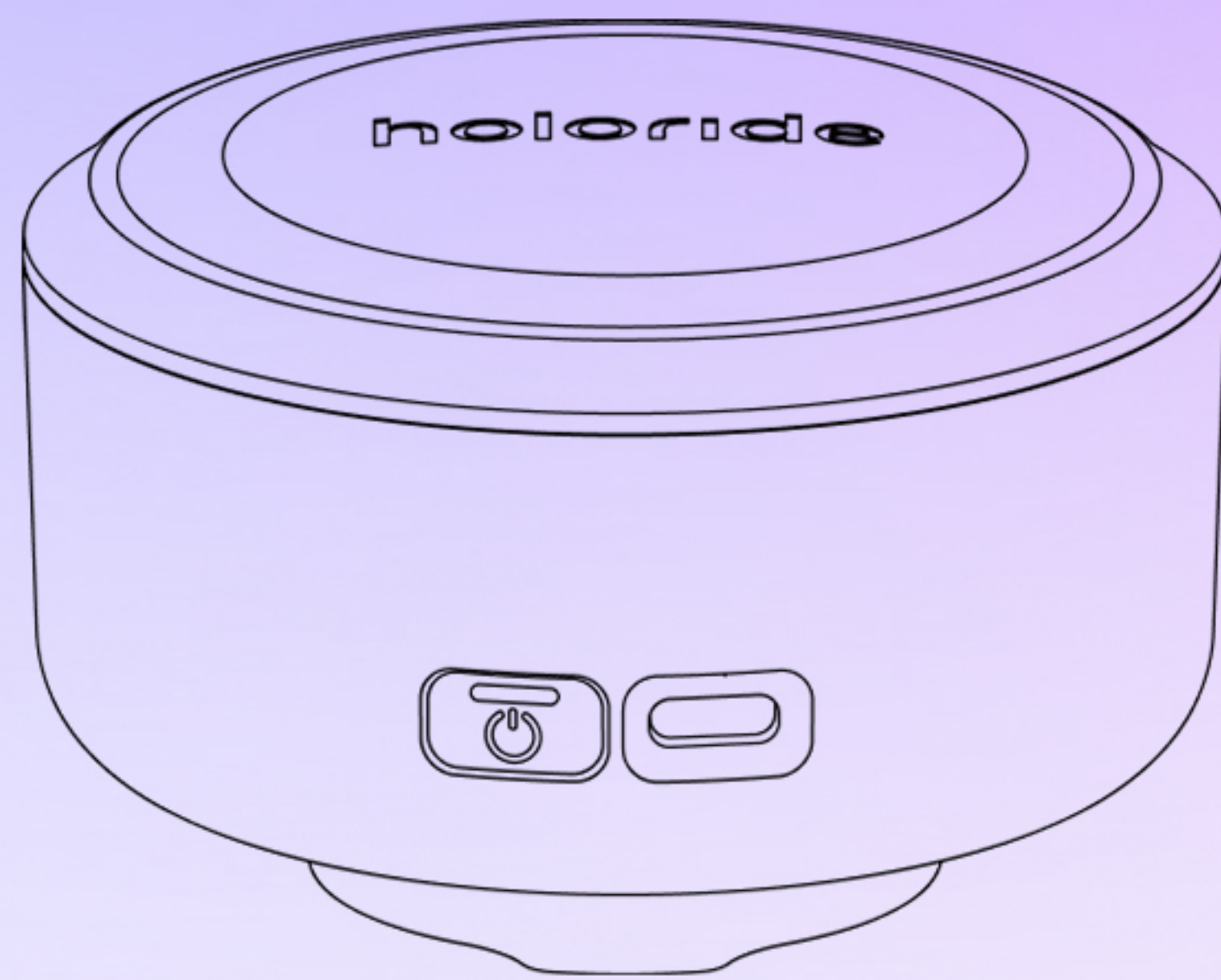

holoride retrofit

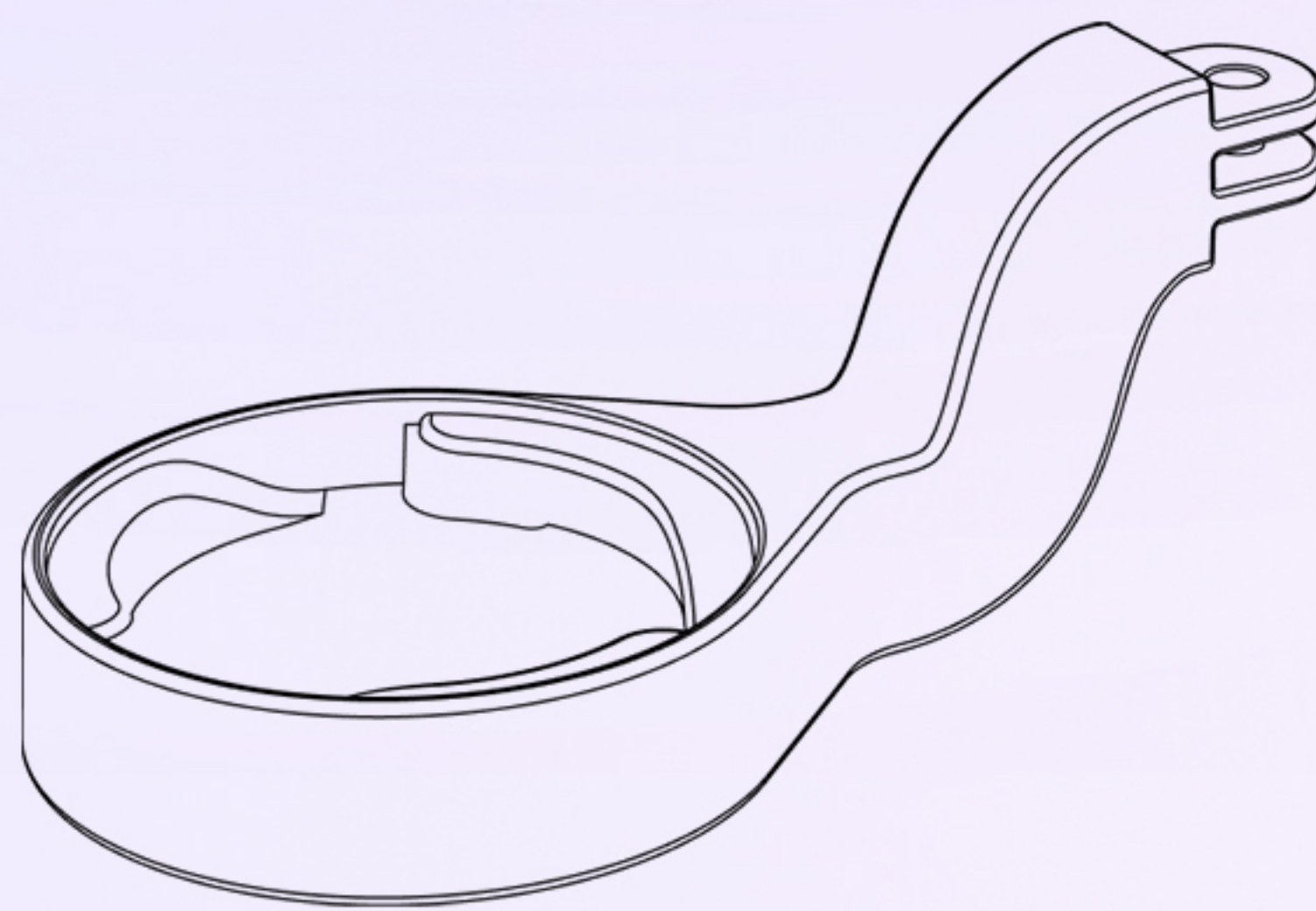

Holder



USB-C Charging Cable

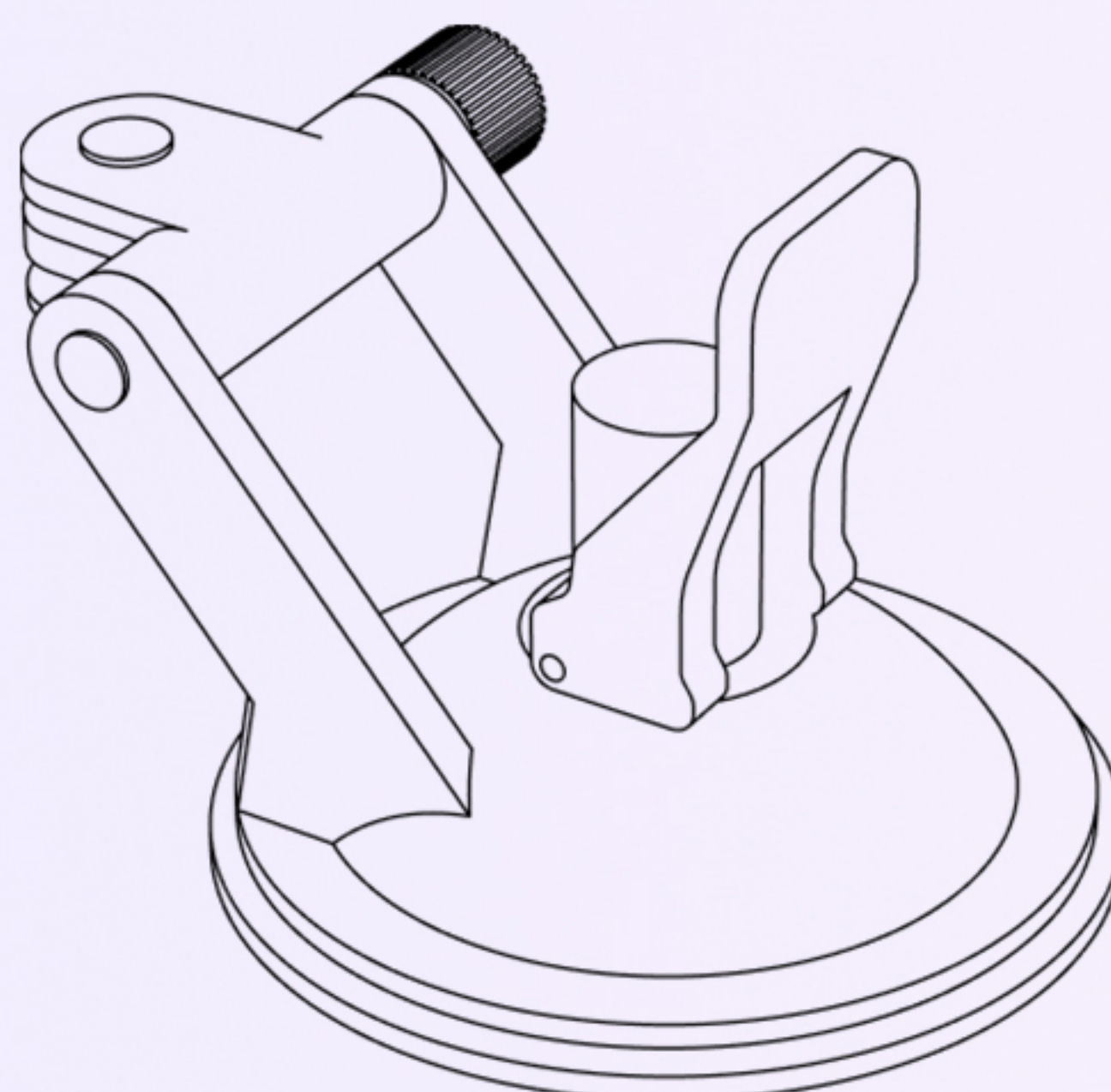

Suction Mount

## 2. Overview of holoride retrofit

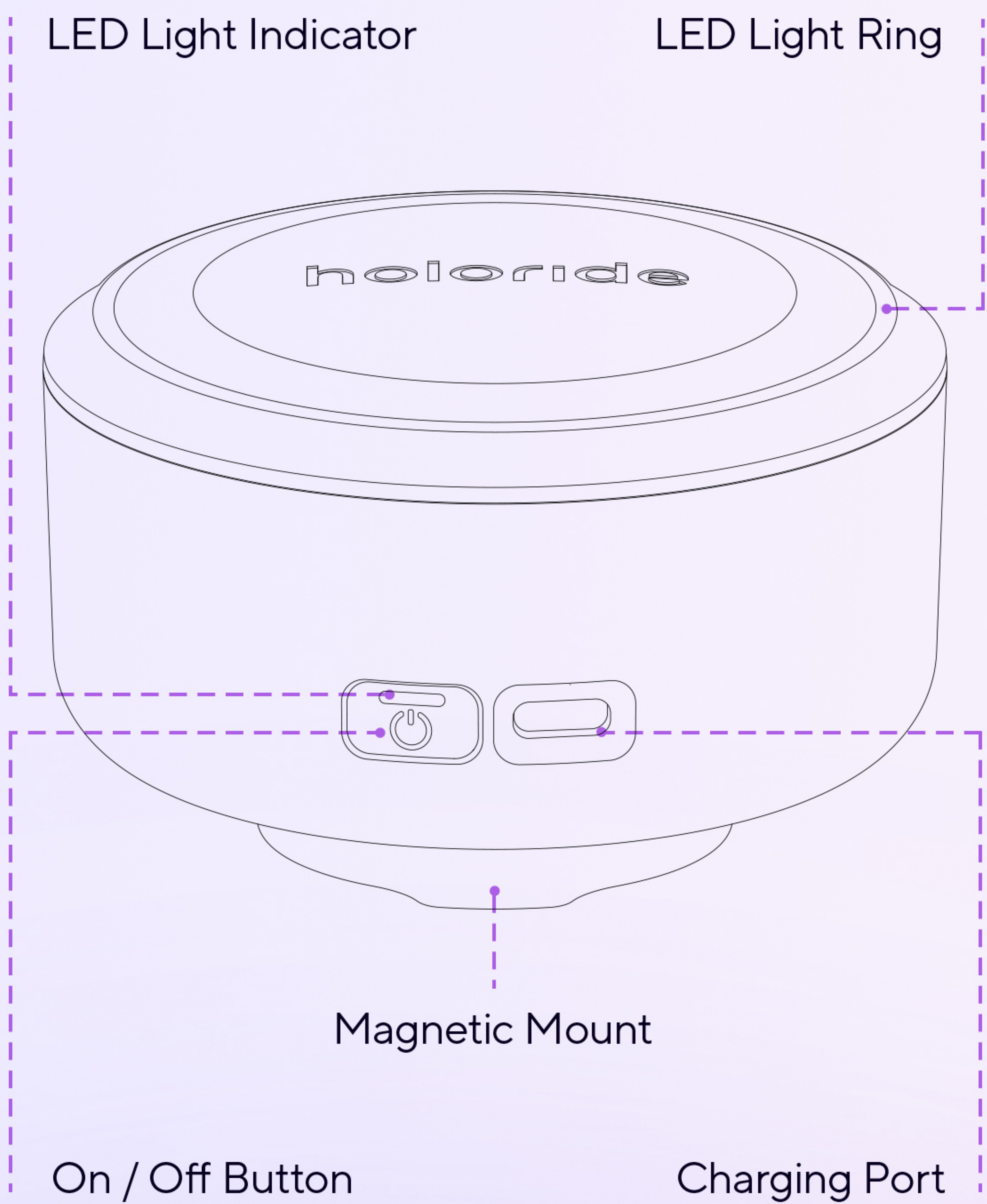

### 3. Prerequisites to use holoride retrofit

Before installing the holoride retrofit in your car, be sure to have completed the setup:

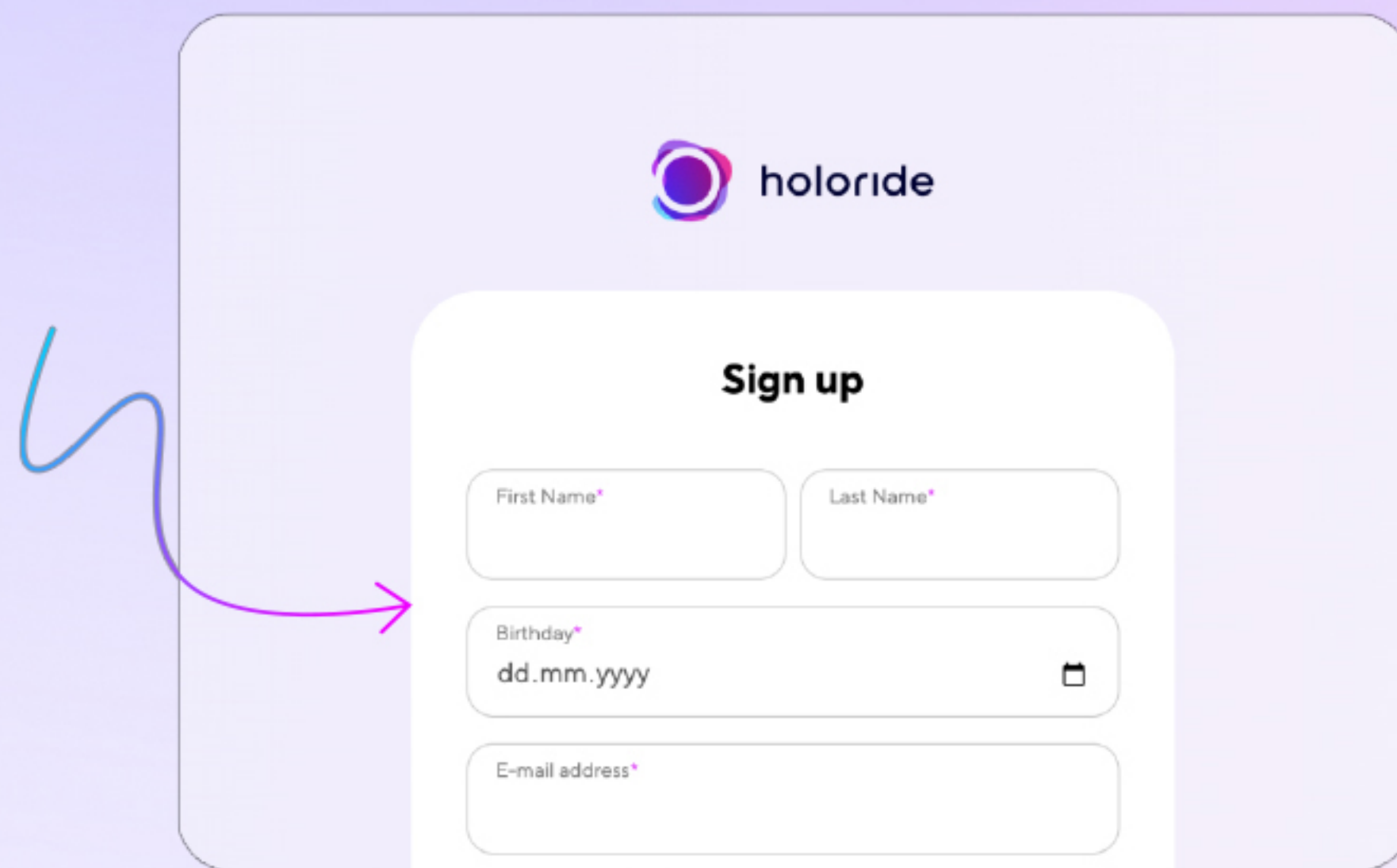

1. Make sure you have an account on [my.holoride.com](https://my.holoride.com) with an active monthly or yearly subscription.

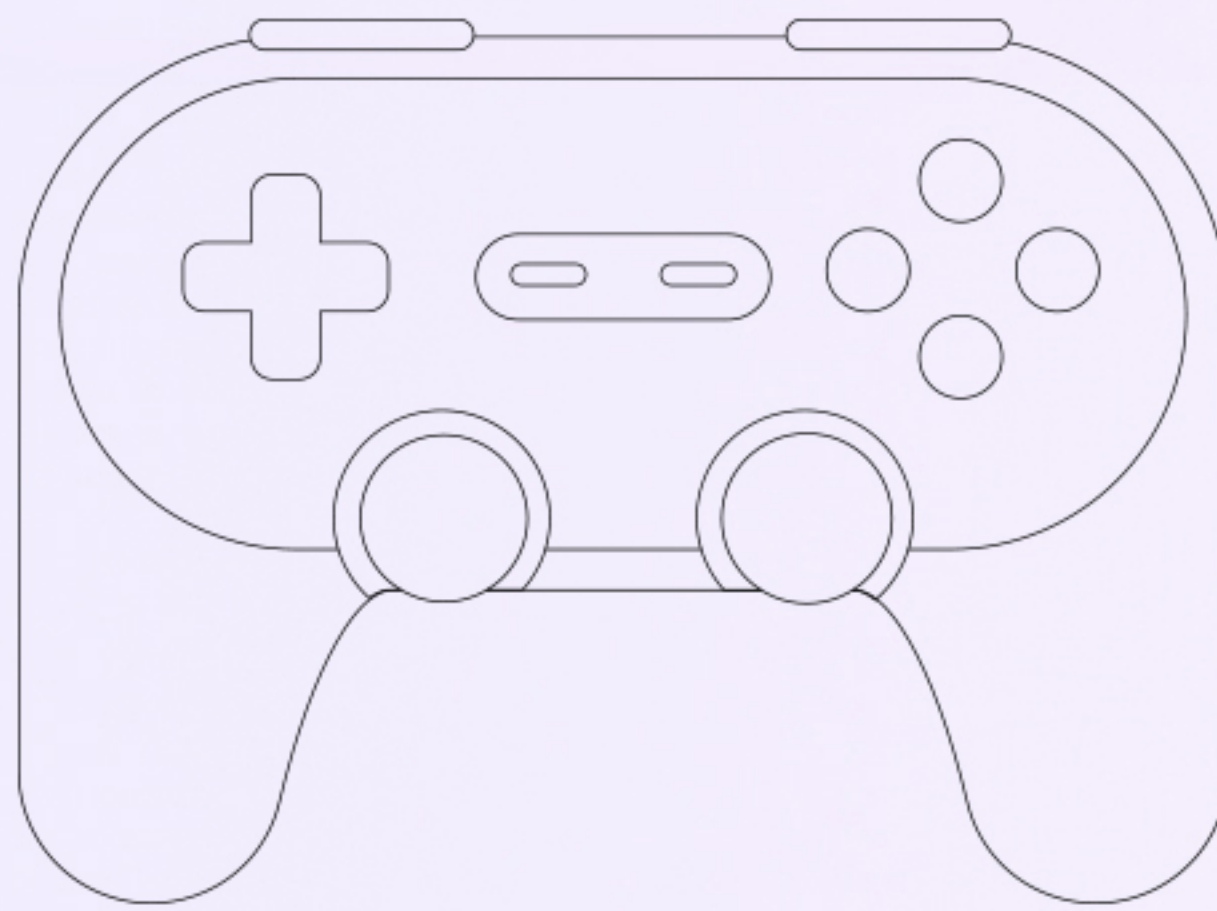

2. Have your holoride compatible game controller (8BitDo Pro 2) ready to navigate in the holoride app.

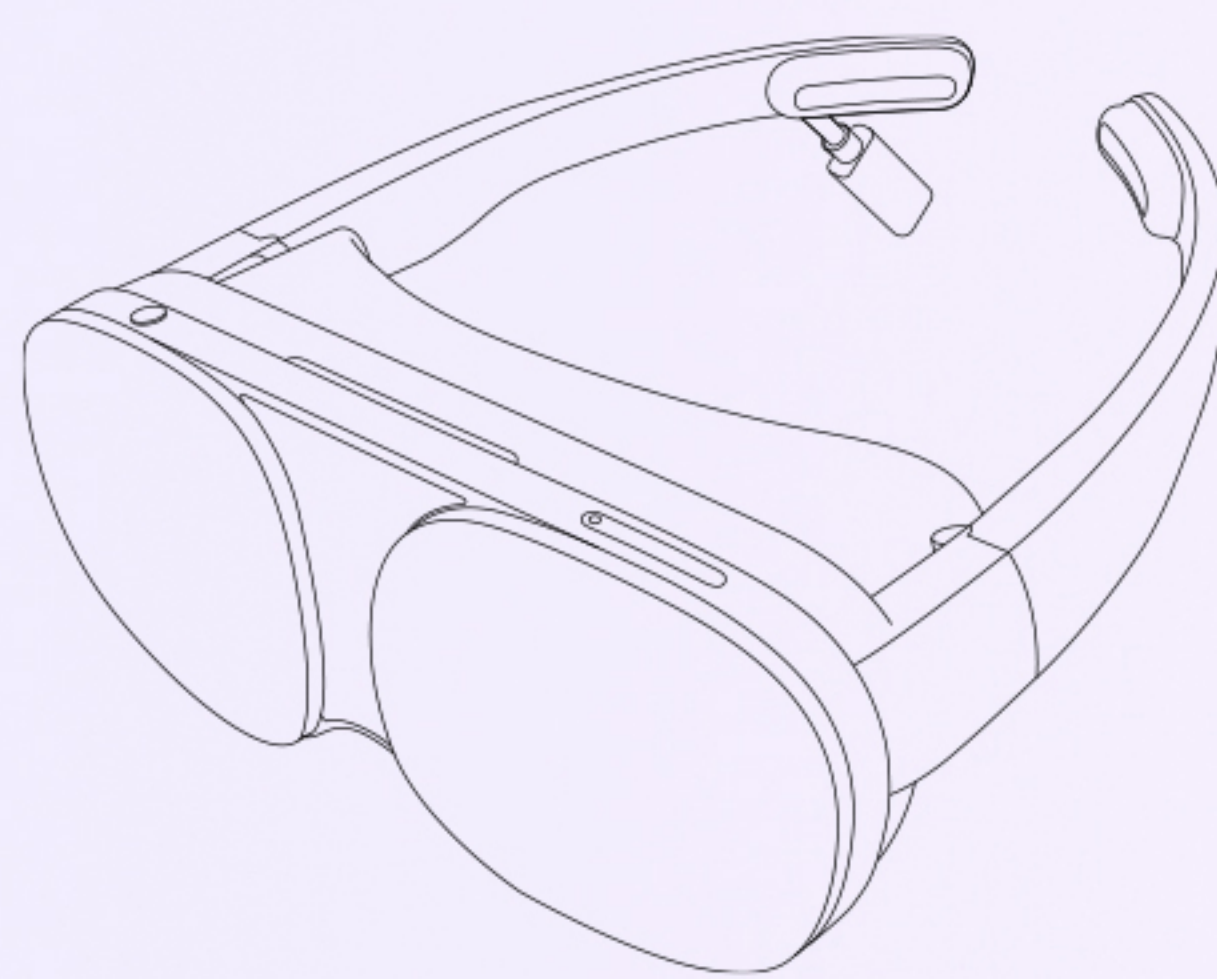

3. Check that your holoride compatible VR headset (HTC VIVE Flow) has firmware 1.84.623.01 or higher installed in order to use holoride.

Then complete the holoride onboarding.

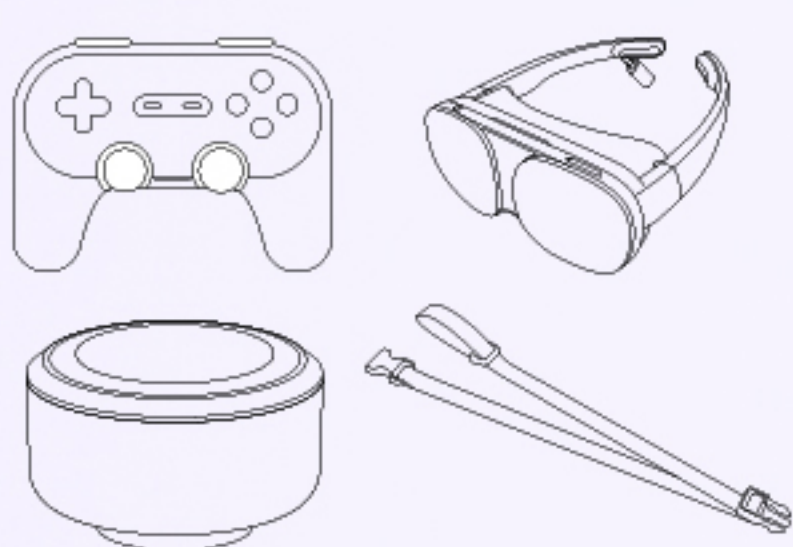

Are you missing something? Visit [shop.holoride.com](https://shop.holoride.com) to find all of our available and compatible equipment.

## 4. Mounting position in your car

Get the most out of your holoride experience by choosing the right position and angle for the holoride retrofit in your car.

### 4.1 Choose mounting position



Ensure that the mounting position does not distract the driver or interfere with their view of the road, controls or any airbags. Pay close attention at all time, and obey all local traffic laws.

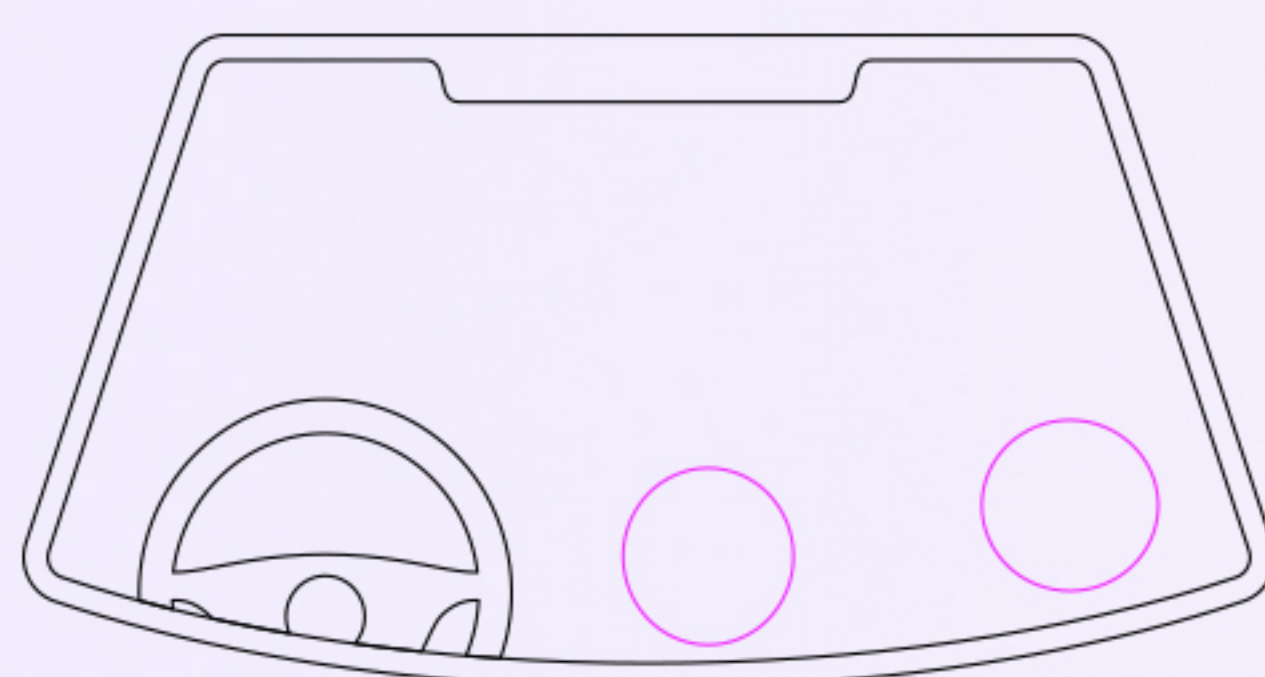

#### Option 1: Windshield

On the windshield, position your holoride retrofit either in the lower right corner, or at the middle bottom of the windshield. The accompanying diagram shows where to safely attach your device.

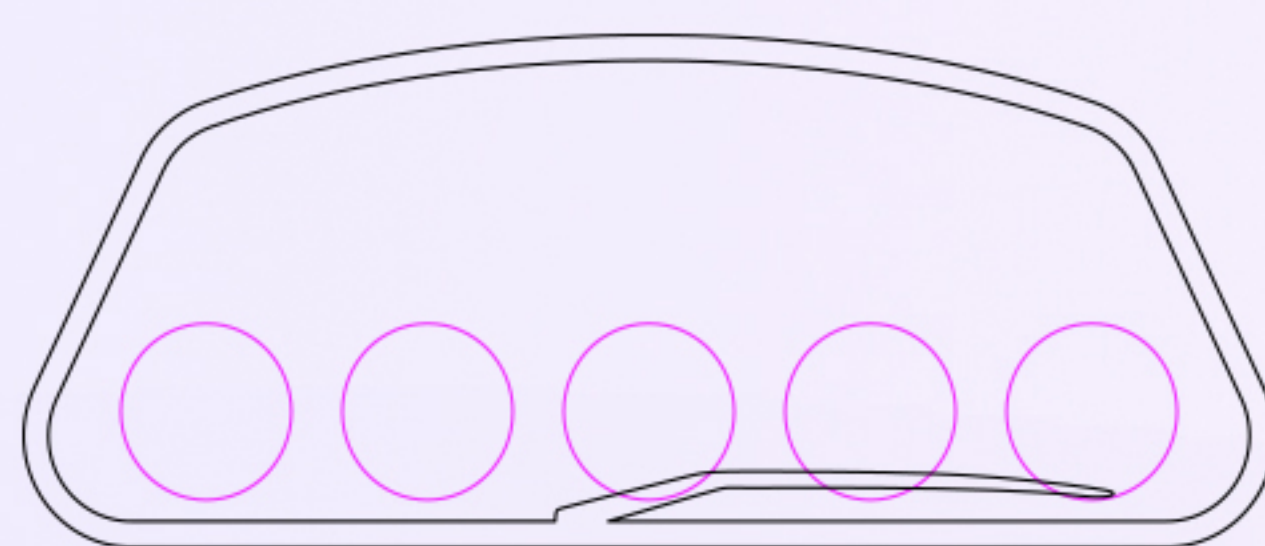

#### Option 2: Back window

On the back window mount your holoride retrofit as shown in the diagram.



Should the front or rear window have an integrated heating or any other reason that limits the effectiveness of the suction mount or that limits the reception of GPS signals, use a side window instead.

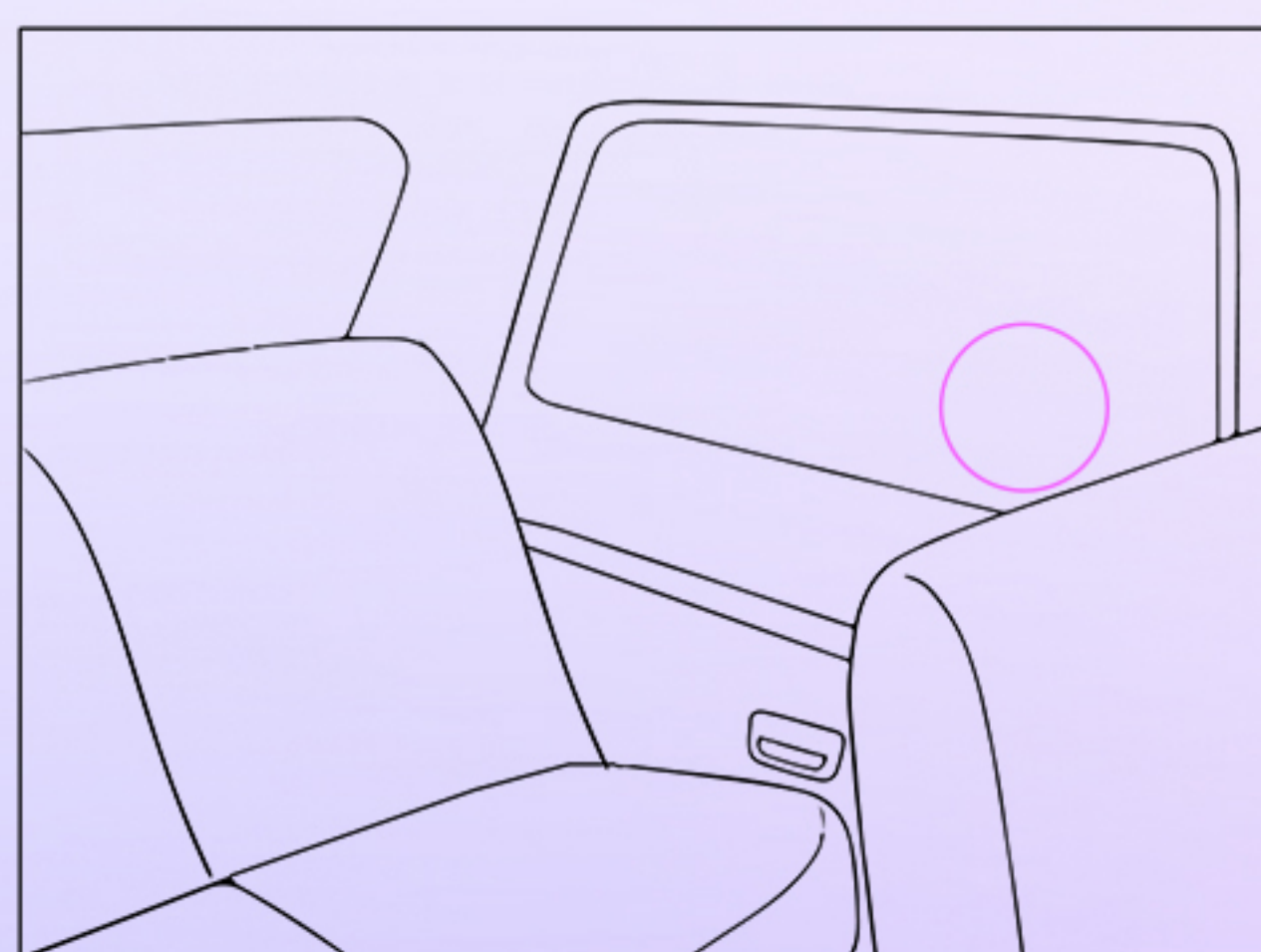

#### Option 3: Passenger Windows

When mounting your holoride retrofit on the rear side passenger windows, ensure that the retrofit is placed low and away from the passenger.



When choosing a side window as mounting position, take extra care when opening and closing the doors and windows.

## 4.2 Mounting on window



1. Clean and dry the selected mounting position on the window.

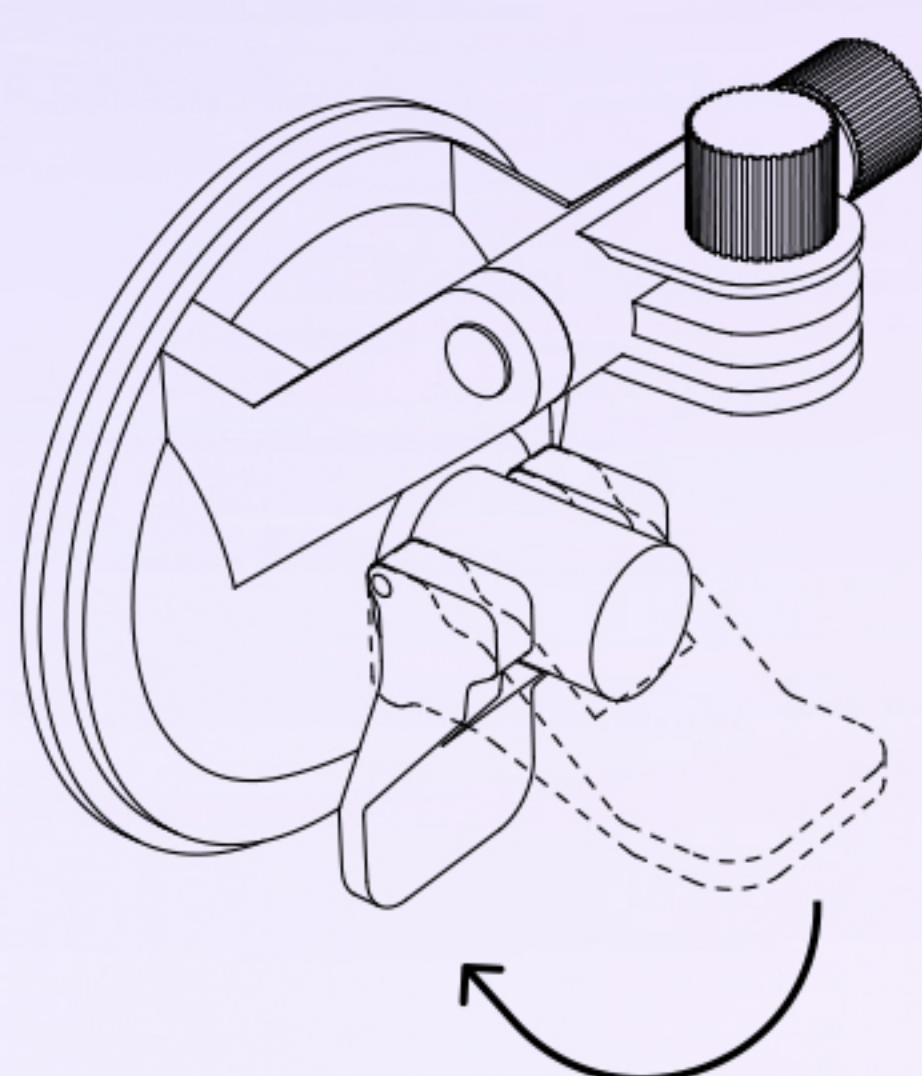

2. Position suction mount on cleaned area with the lever in the up position. Press against window, and push the lever down to create a tight seal.

Make sure that the fixation is strong enough to hold the weight of the holoride retrofit.

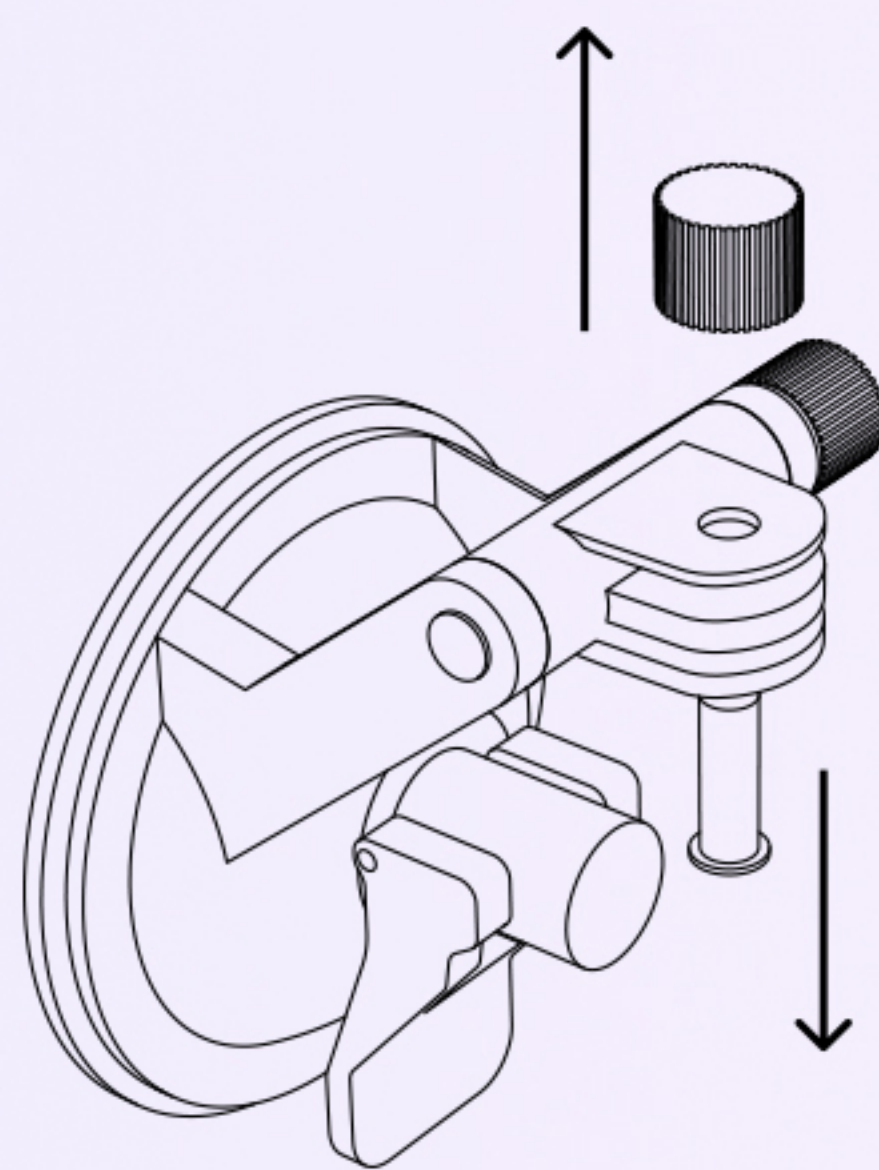

3. Remove thumb bolt and screw.

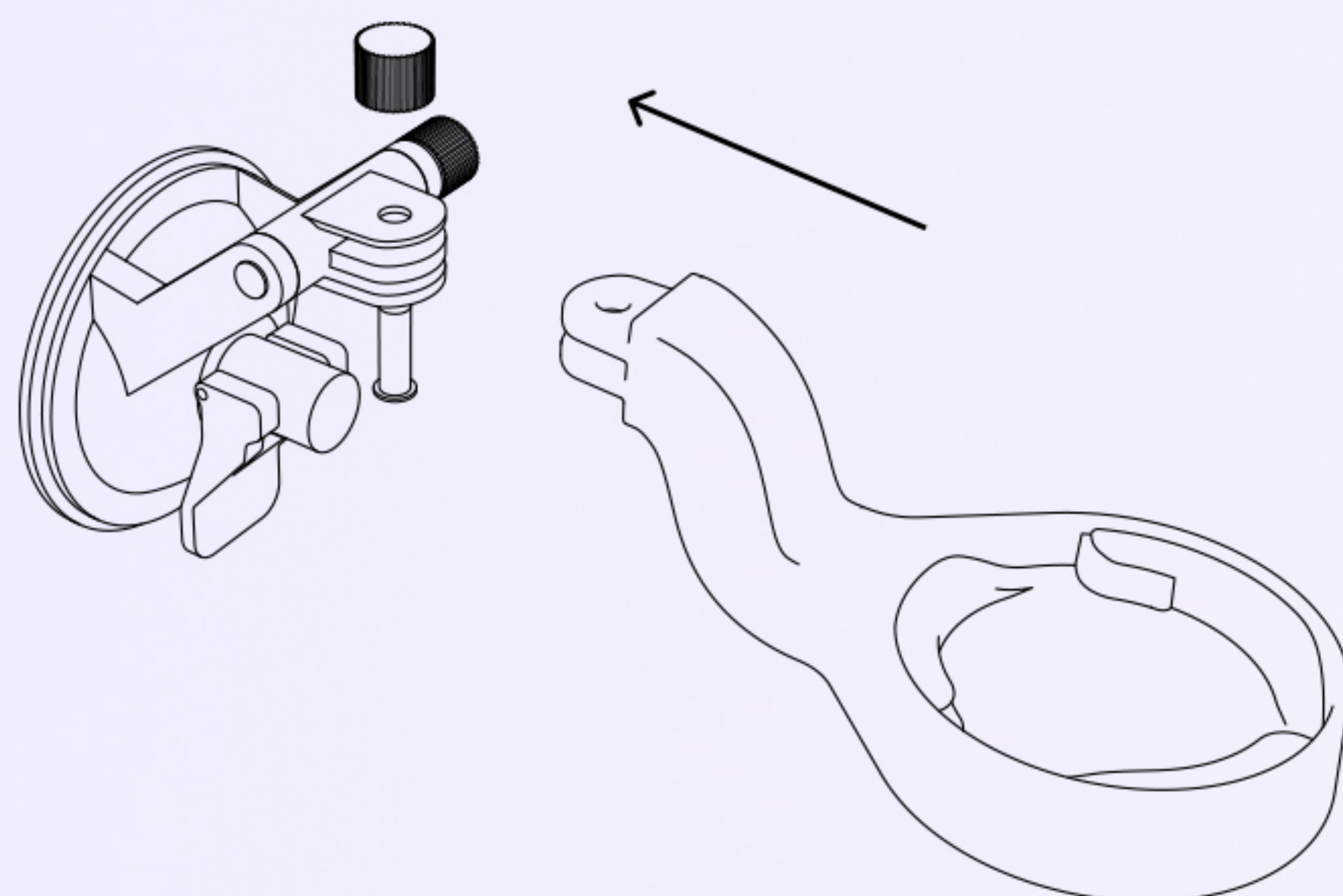

4. Insert the holder into the suction mount with the holoride mounting spot facing upward.

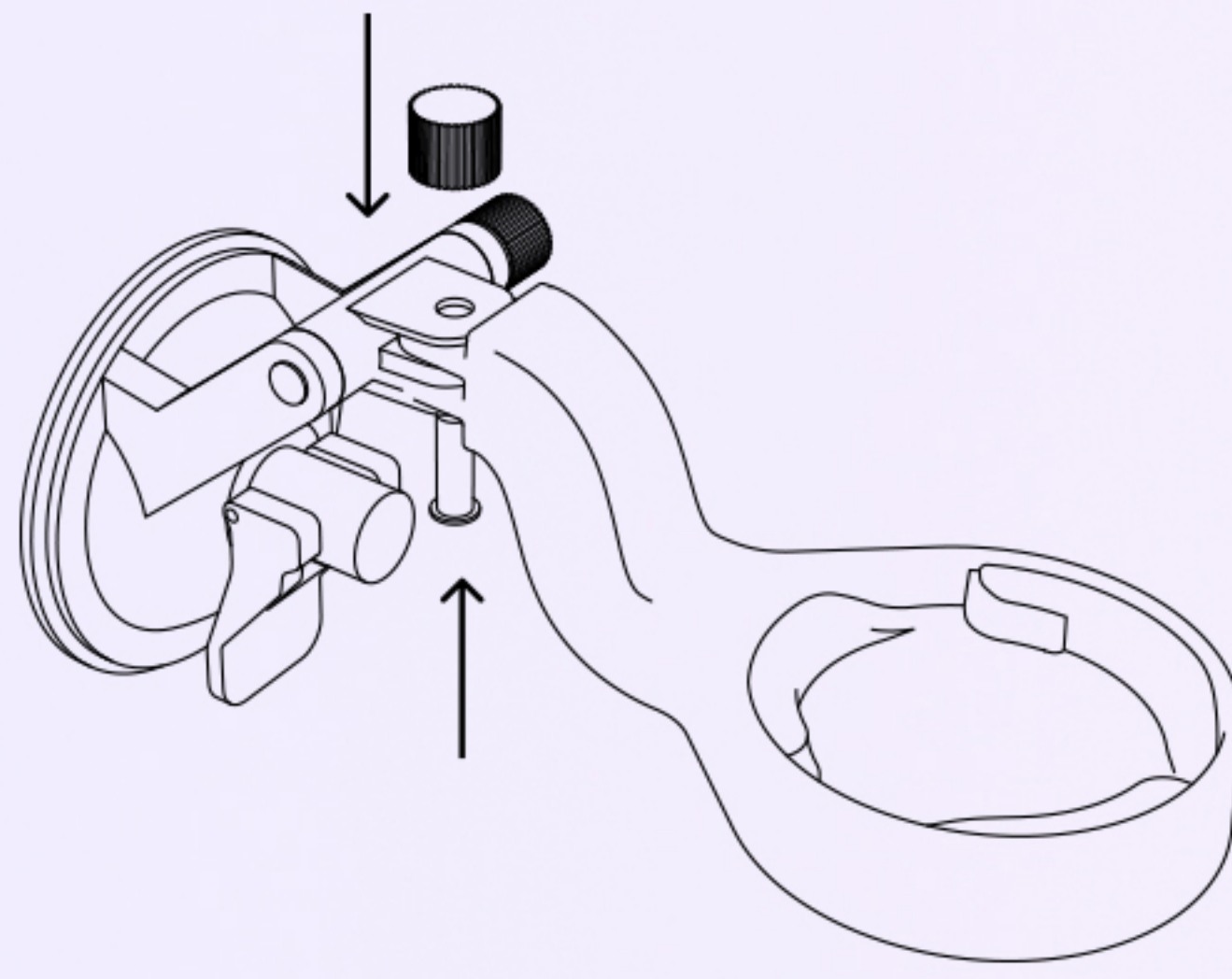

5. Insert the screw and reattach the thumb bolt. Fix the screw tight enough to avoid any movement of the holder.

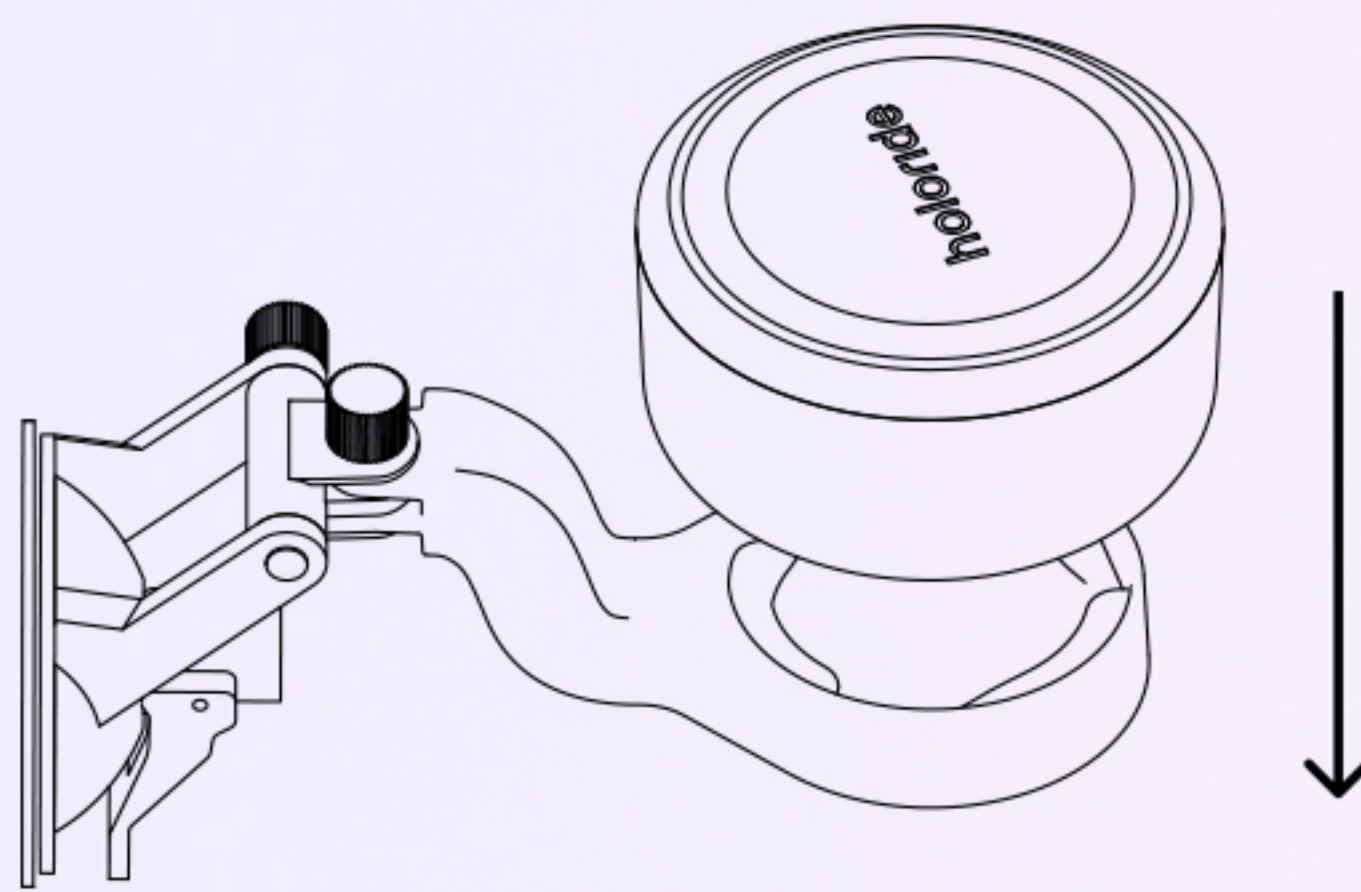

6. Place the holoride retrofit into the holder using the magnetic foot as a guide.

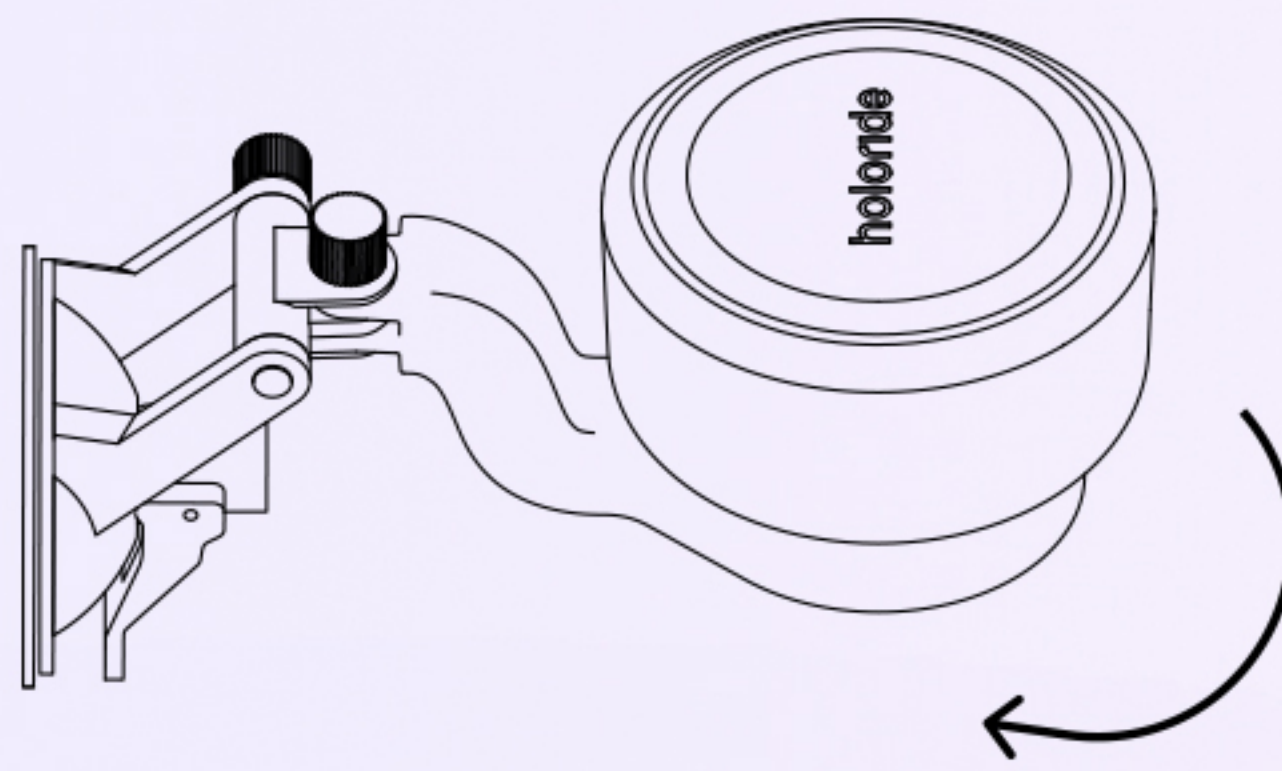

7. Then turn clockwise to lock the foot into the mount. Ensure buttons and charging port are facing away from the window.



## 4.3 Adjust to correct mounting angles

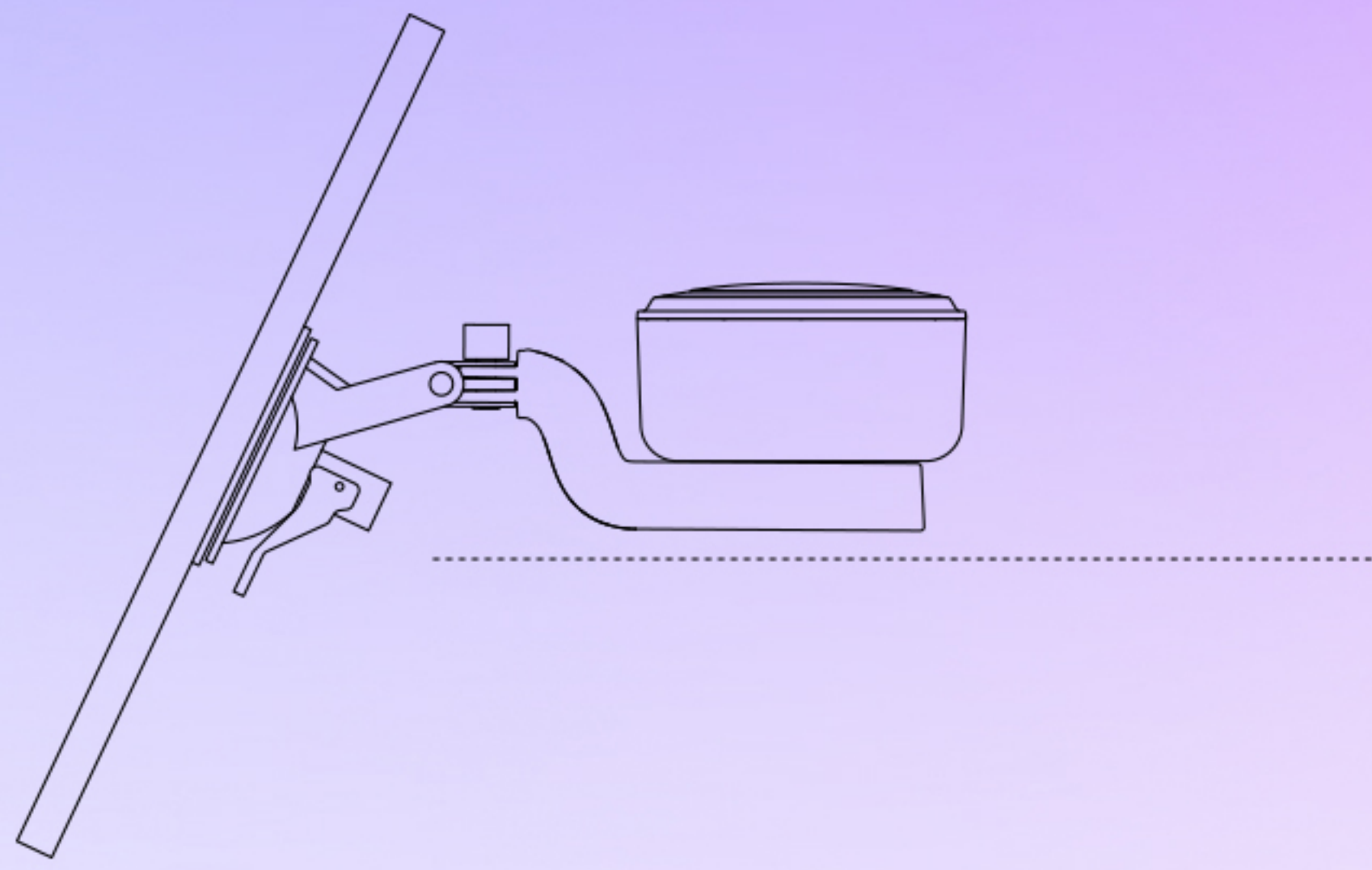

View from the side: The holder must be horizontal to the ground.

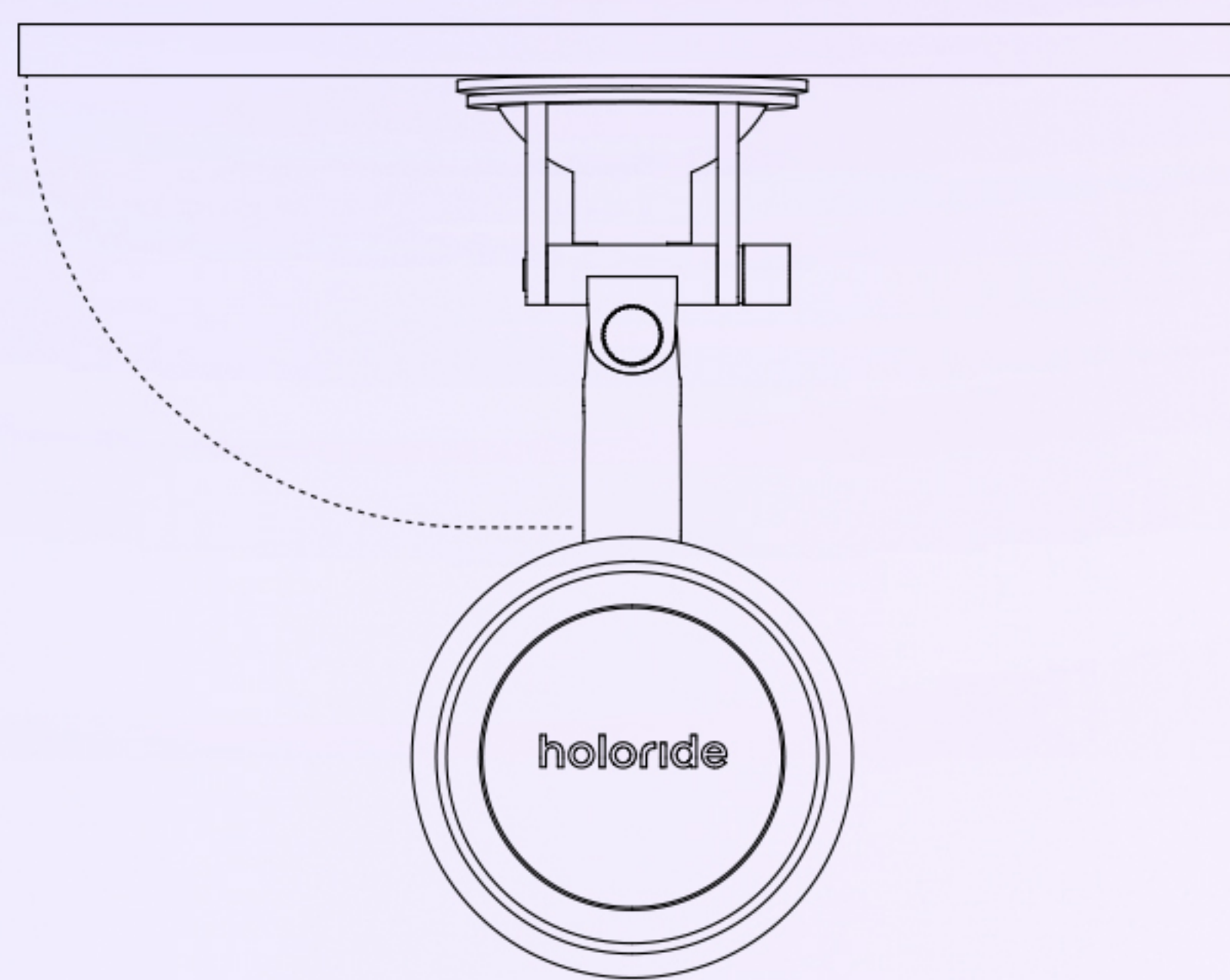

View from the top: The device must be in a 90° angle to the window it's mounted on.



Failing to adjust the holoride retrofit to the correct angles will negatively effect your holoride experience or prohibit it from working at all.

## 5. Pair holoride retrofit with VR headset

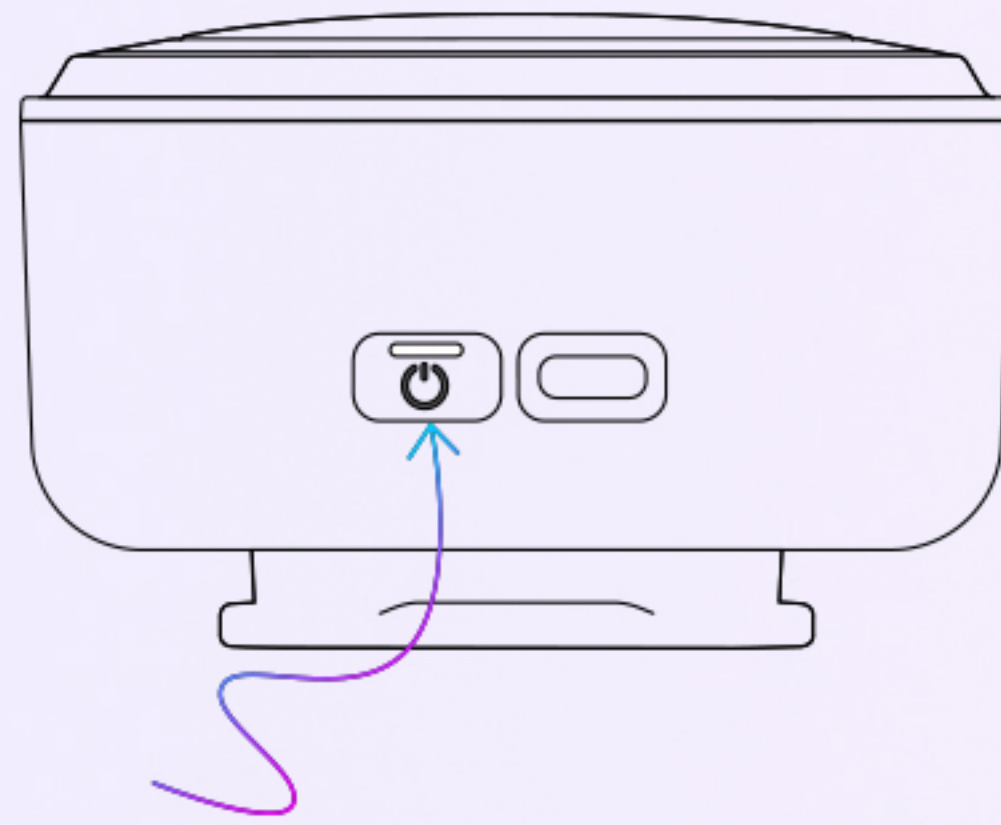

1. Turn on your holoride retrofit by pressing the power button for 2 seconds. The top LED ring will light up and circle in various colors.

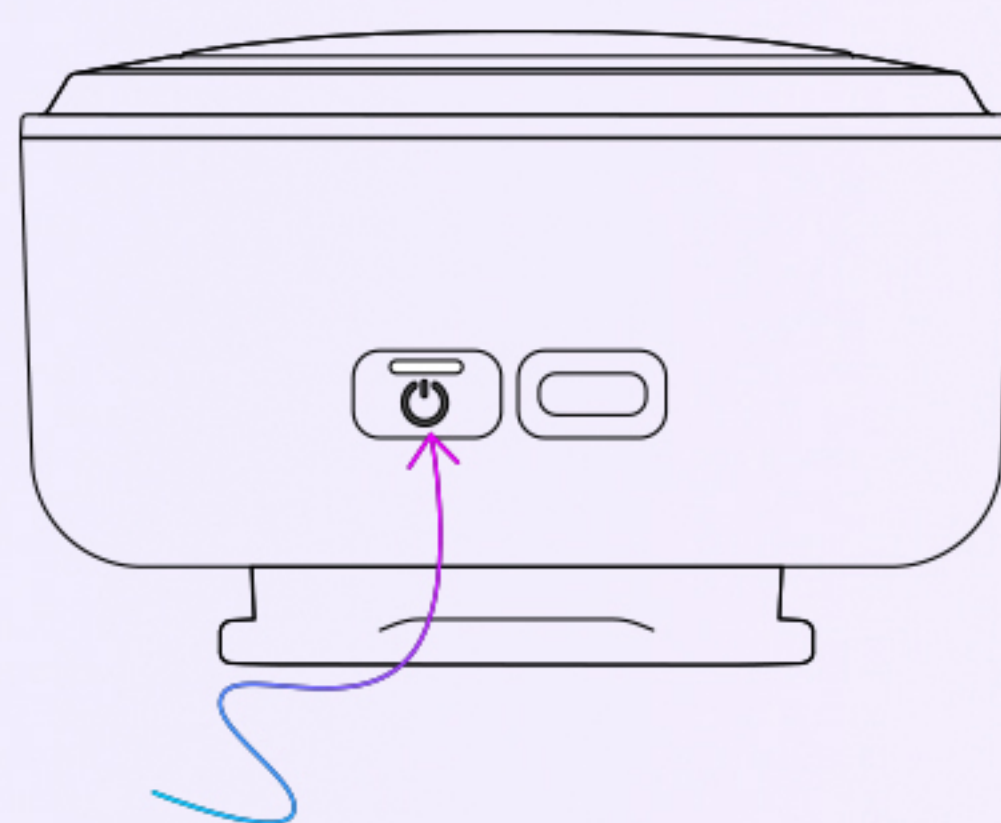

2. Double press the power button to activate pairing mode. The top LED ring will pulsate in blue when pairing is possible.

Do you have a new VR headset to set up? Find all relevant information on how to do the setup on [service.holoride.com](https://service.holoride.com)

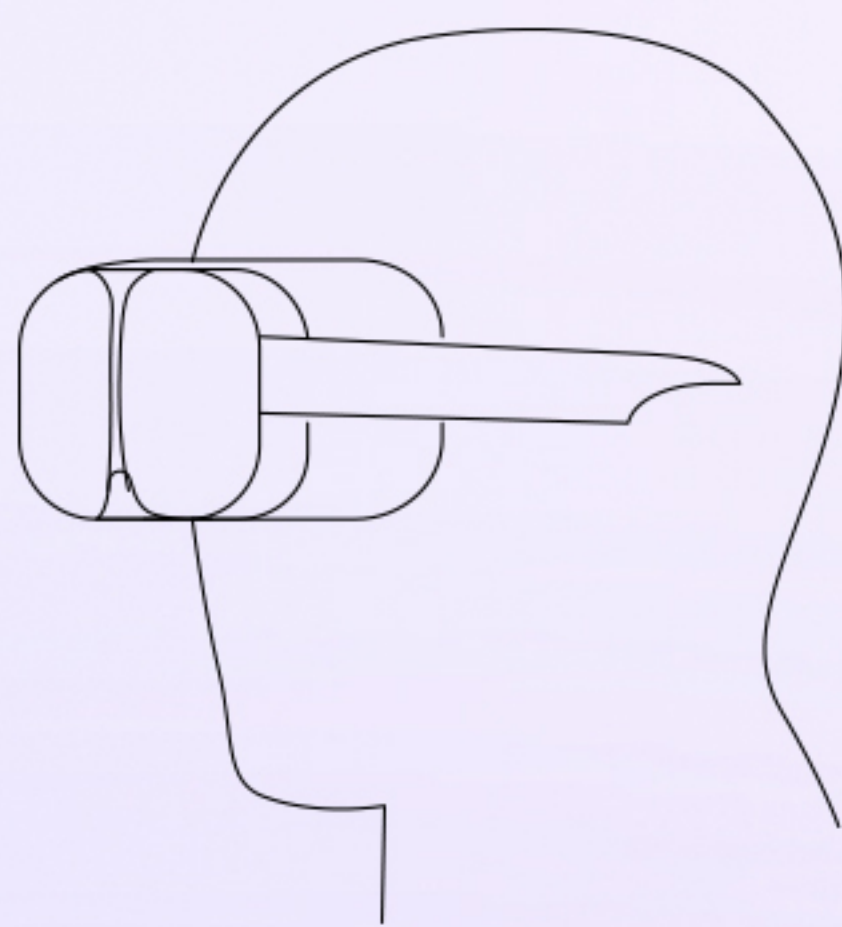

3. Put on your holoride compatible VR headset and open the holoride app.

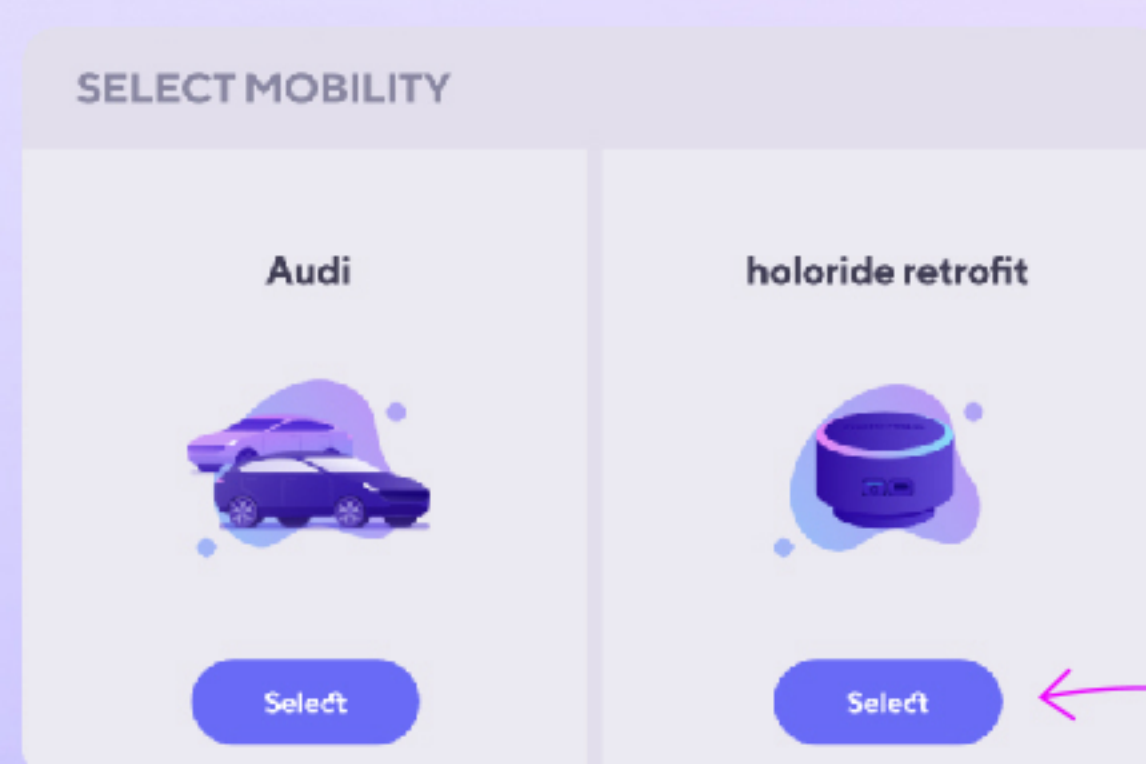

4. In the menu bar click on the car icon to connect a mobility sensor. Next, follow the holoride retrofit setup instructions in the app.

5. Start driving. Your holoride retrofit will start to collect location data and your experience will begin.

**Info:** Double the fun! Each holoride retrofit can be paired and used with two headsets at the same time.

## Recenter your VR view

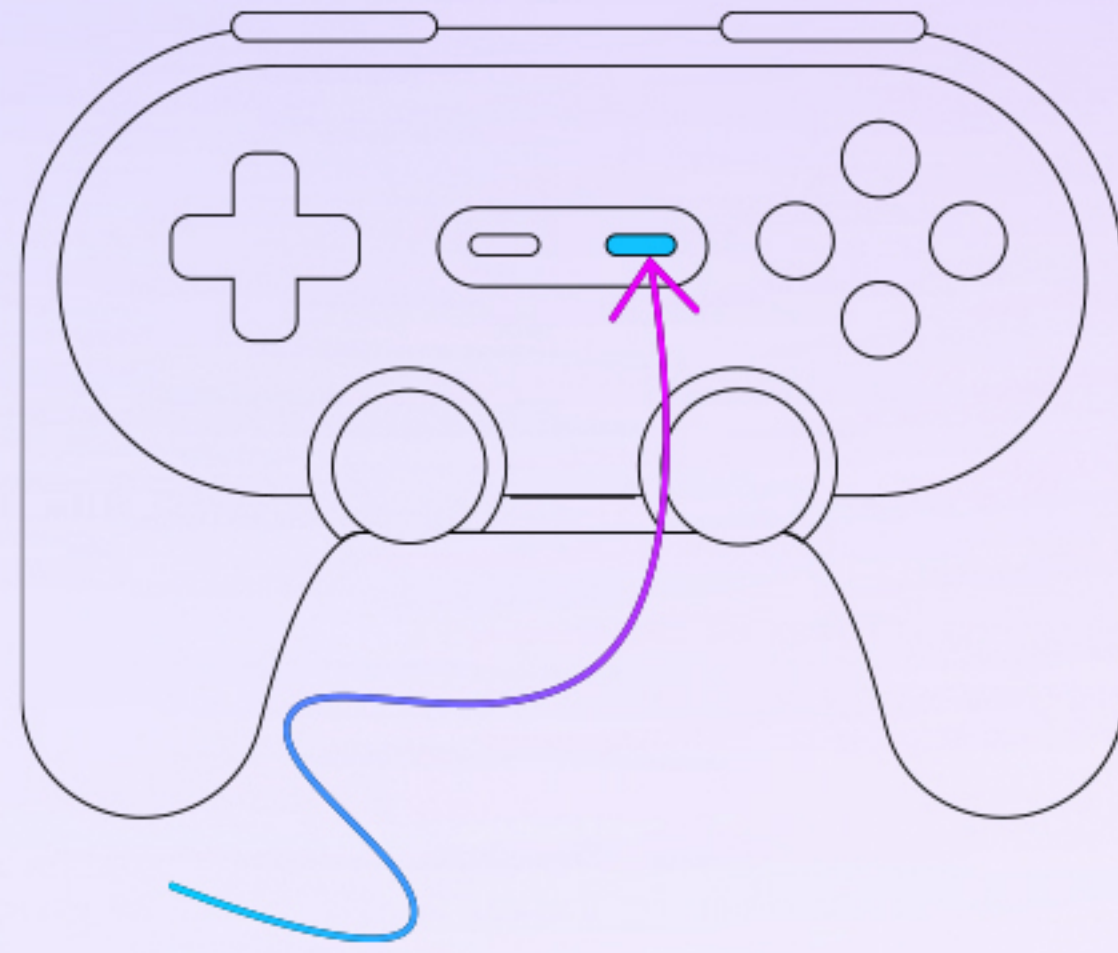

In case the movement in your VR feels off e.g. you are moving backward or in any other direction than your car is moving:

Click the “start” button to recenter your view.

## Unpair a holoride retrofit

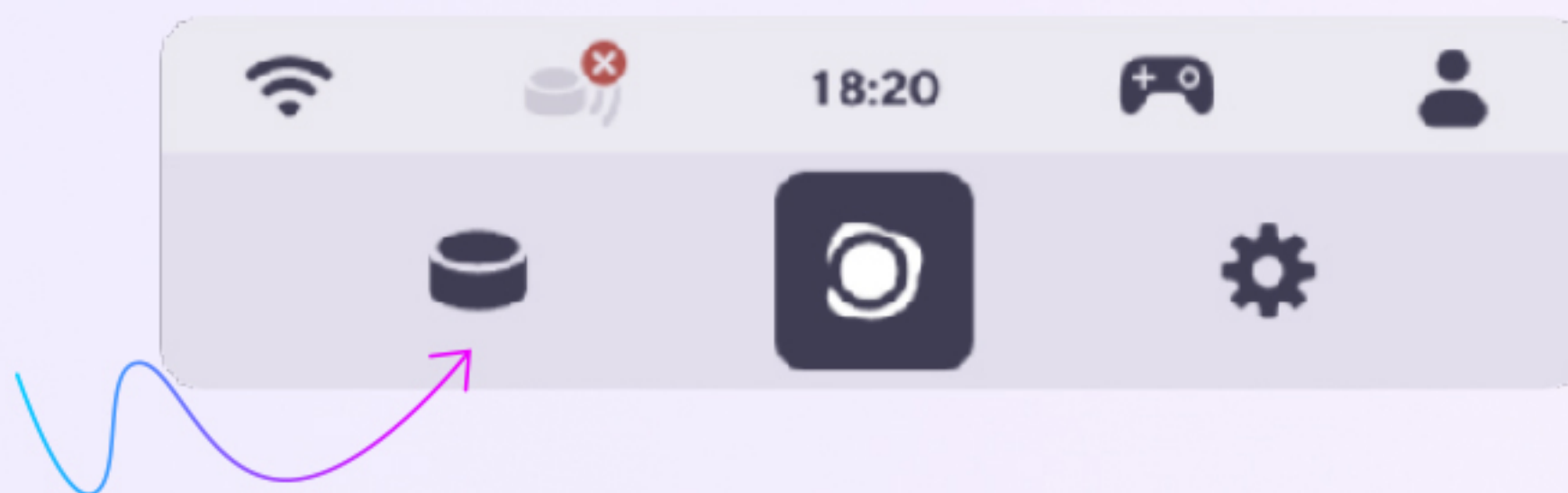

You can easily unpair a device in the settings of the holoride app inside your VR headset.

Open the motion sensor settings by clicking on the holoride retrofit icon in the app bar.

**Info:** The app bar will show a car icon, in case no holoride retrofit is connected.



Choose “Delete sensor” to permanently unpair your holoride retrofit.

## 6. Button & LED signals

### Turn retrofit on and off

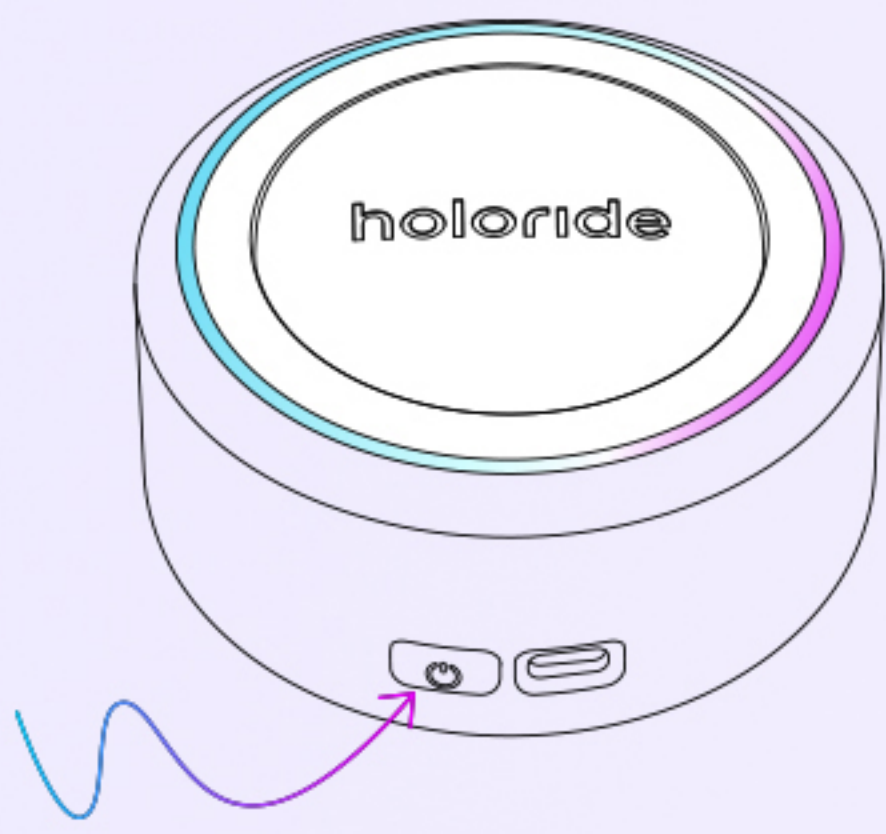

**Turn on:** Press power button for 2 seconds. The LED ring will show circling colors for 20 seconds, and then fade out.

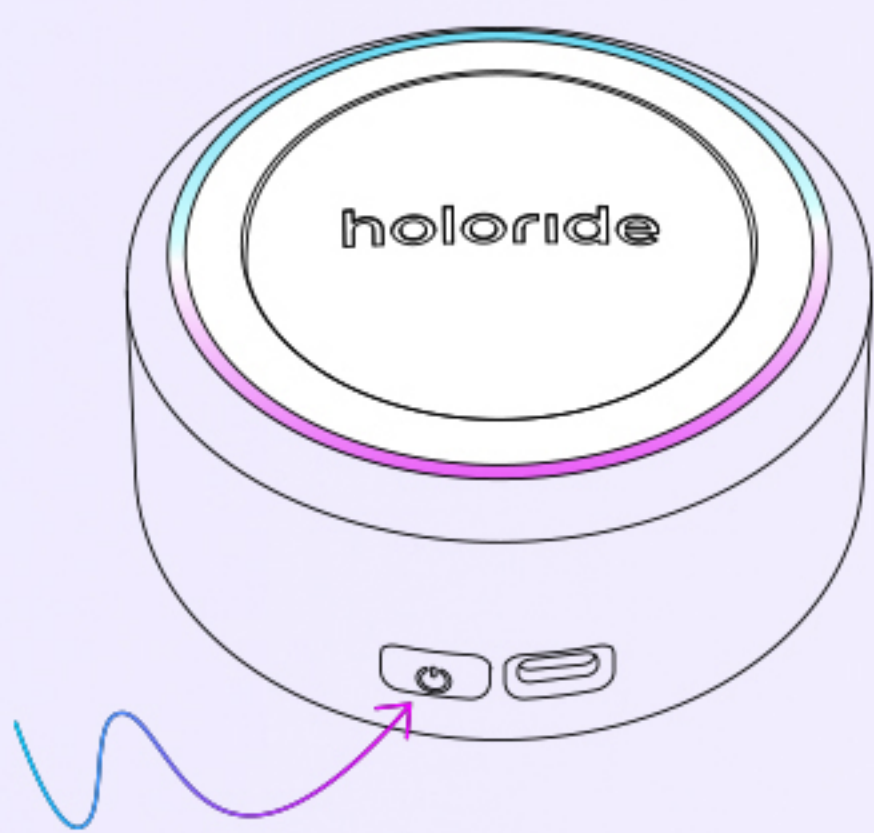

**Turn off:** Press power button for 3 seconds. The LED ring will circle colors and fade out.



If the device is out of battery it will turn off automatically. The ring will pulsate in red and fade out.

**Note:** If holoride retrofit is inactive for 30 minutes it will automatically power off.

### Check battery status

Press power button once to check battery status at any time.

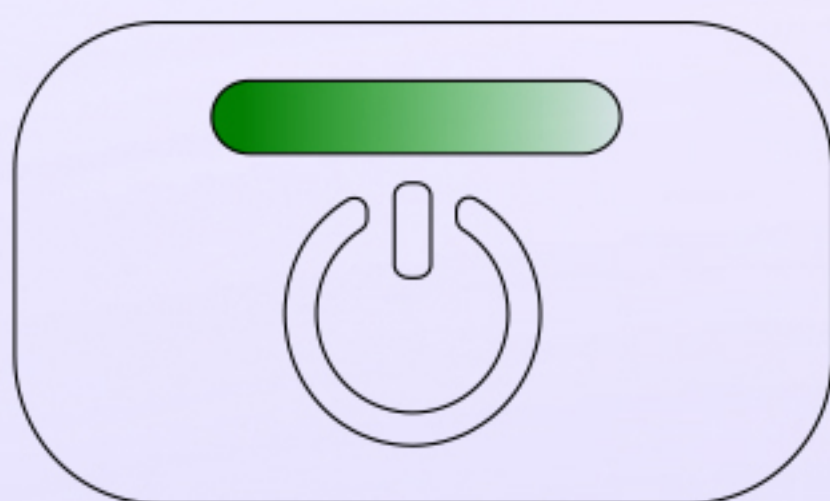

LED indicator light turns green when battery is fully charged.

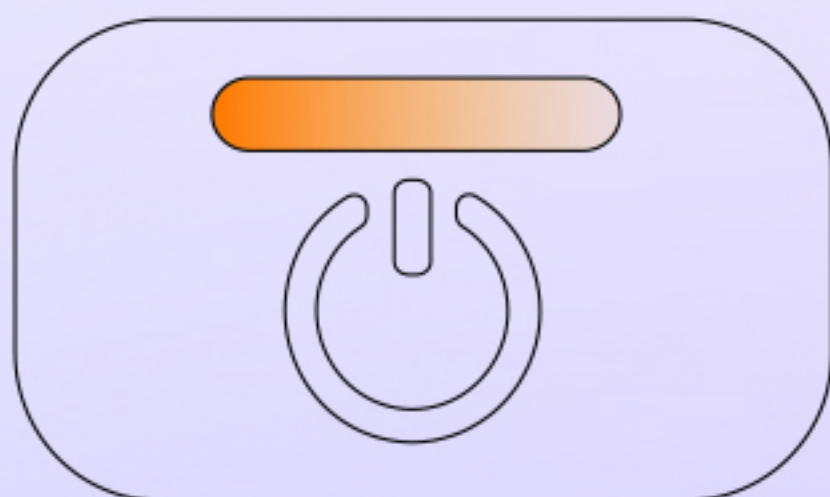

LED indicator turns orange when battery needs to be charged soon.

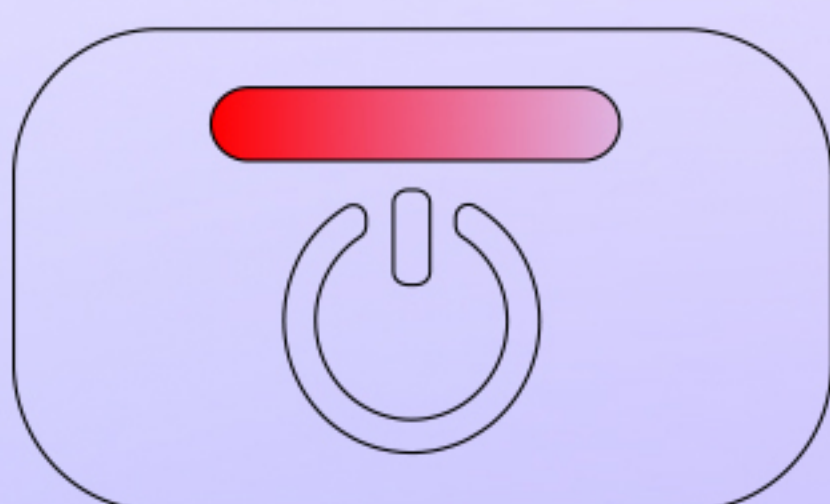

LED indicator turns red when battery is low and needs charging.

Charge your holoride retrofit by connecting the power cable to the charging port. The LED indicator lights up for one second to show the battery status.

## Localization data

Localization data synchronized to the holoride retrofit is what allows you to experience the motion-synchronized environment in your VR headset.

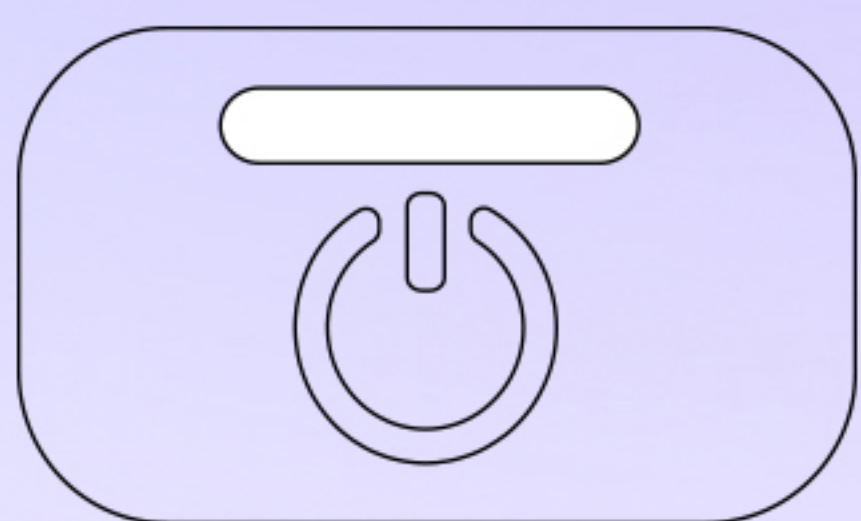

LED is solid white if the holoride retrofit has a stable connection.

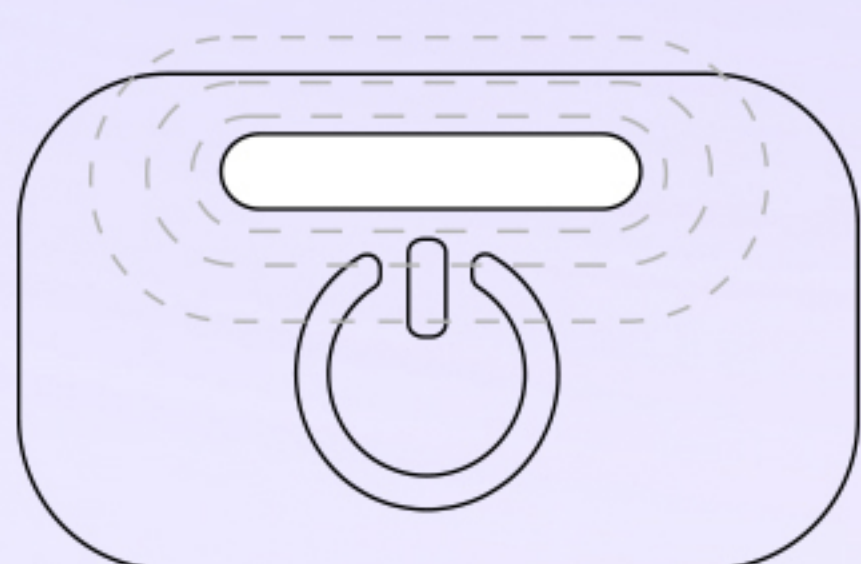

LED pulsates white when the device is searching for a connection.

## Pairing mode

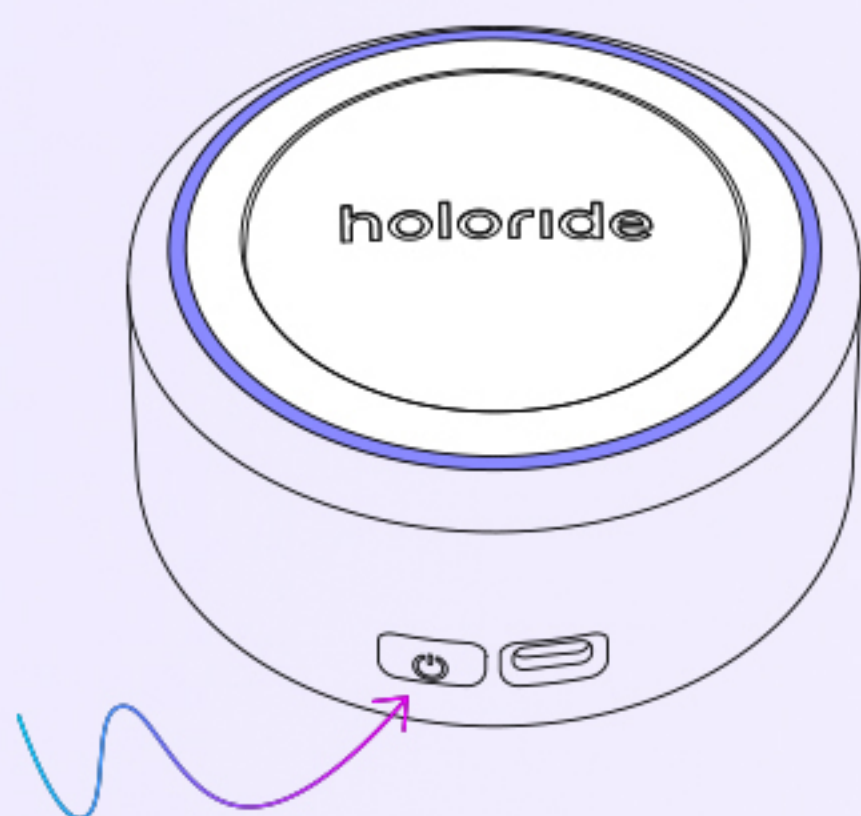

Activate pairing mode by double pressing the power button. The LED ring will pulsate blue.

Once paired, the LED ring is solid blue for 3 seconds and fades out.

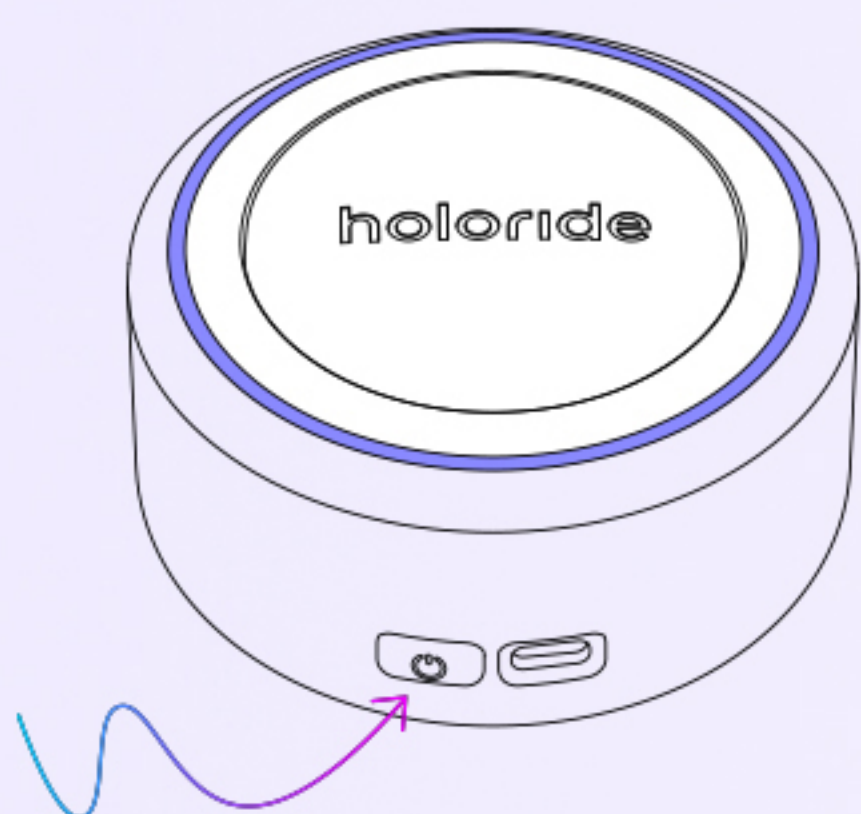

Deactivate pairing mode by double pressing the power button. The LED ring will pulsate blue 3 times and then fade or return to its previous state.

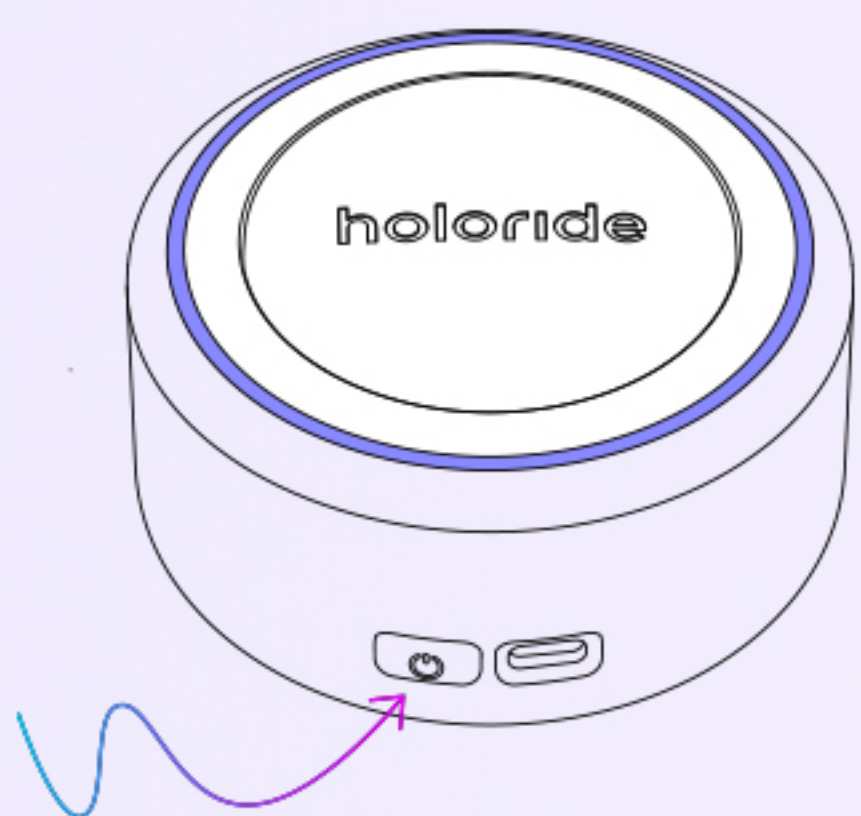

Erase existing pairings with 2 short presses and 1 long press on the power button. The LED ring will pulsate 3 times and then reboot.

Do you have further questions?

Go to **[service.holoride.com](https://service.holoride.com)** to find all your answers!

Do you have a specific question?

Reach out to us directly, and write us an email at:

**[support@holoride.com](mailto:support@holoride.com)**

Customers located in the US, please write us an

email to: **[support-us@holoride.com](mailto:support-us@holoride.com)**



**holoride**